

To the motor coils

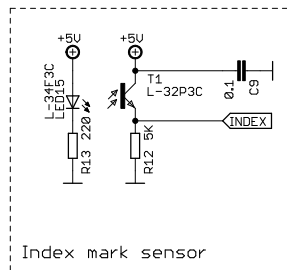

Index mark sensor

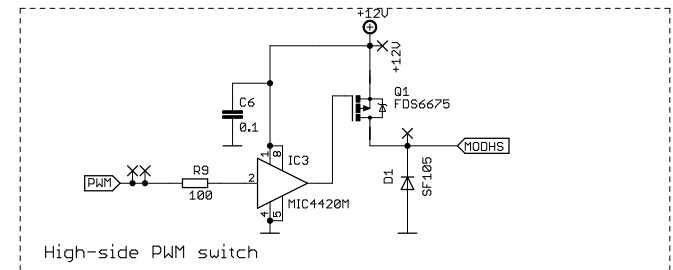

High-side PWM switch

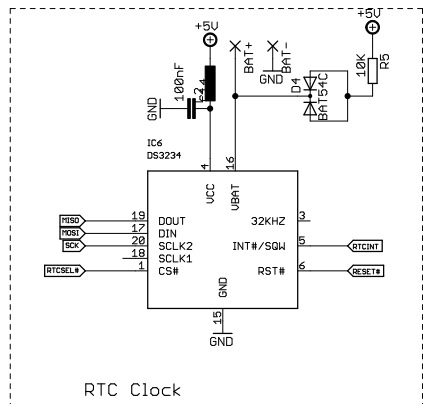

RTC Clock

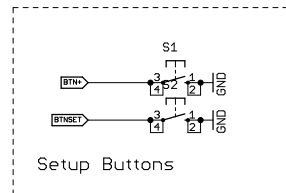

Setup Buttons

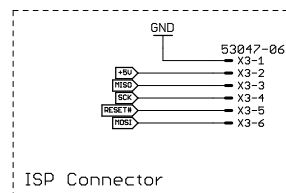

ISP Connector

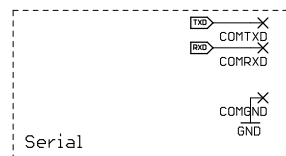

Serial

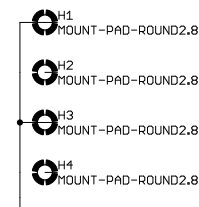

# STROBESHNIK

CONTROL BOARD  
REV.B 14.03.10

HDD Strobe Clock  
Viacheslav Slavinsky

<http://sensi.org/~svo>  
St.Petersburg 2010